

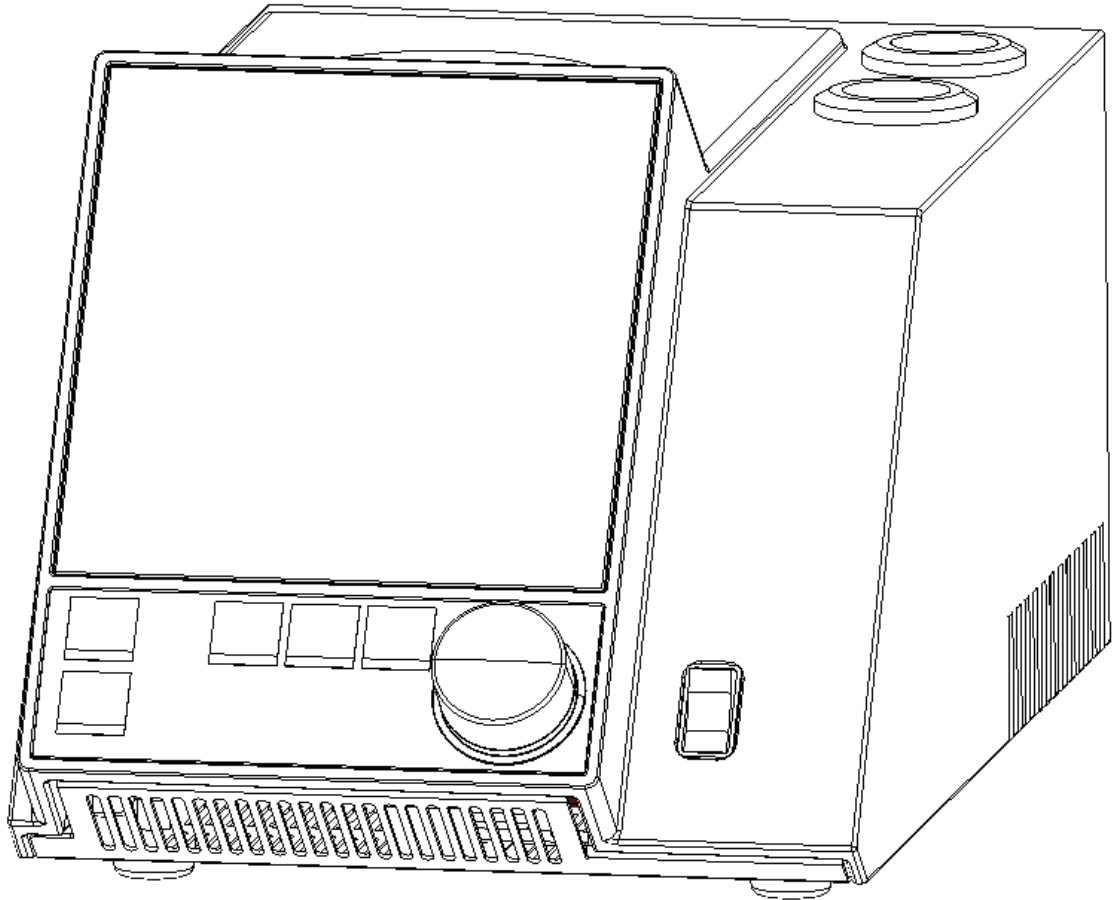

Melting Point M-560

Operation Manual



Imprint

Product Identification:
Operation Manual (Original), Melting Point M-560

0932511 en

Publication date: 10.2019

BÜCHI Labortechnik AG
Meierseggstrasse 40
Postfach
CH-9230 Flawil 1

E-Mail: quality@buchi.com

BÜCHI reserves the right to make changes to the manual as deemed necessary in the light of experience; especially in respect to structure, illustrations and technical detail.

This manual is copyright. Information from it may not be reproduced, distributed, or used for competitive purposes, nor made available to third parties. The manufacture of any component with the aid of this manual without prior written agreement is also prohibited.

Table of contents

1	About this manual	4
1.1	Reference documents	4
1.2	Abbreviations	4
2	Safety	5
2.1	User qualification	5
2.2	Proper use	5
2.3	Improper use	5
2.4	Warning notices used in this manual	6
2.5	Product safety	6
2.5.1	Instrument-related hazards	6
2.5.2	Other hazards	6
2.5.3	Safety measures	7
2.5.4	Safety elements	7
2.6	General safety rules	7
3	Technical data	8
3.1	Scope of delivery	8
3.1.1	Standard accessories	8
3.1.2	Optional accessories	10
3.2	Technical data overview	11
3.3	Materials used	12
4	Description of function	13
4.1	Melting Point	13
4.2	Boiling Point	13
4.3	Controls and connections	14
5	Putting into operation	15
5.1	Installation site	15
5.2	Commissioning	15
5.2.1	Unpacking and installation	15
5.2.2	Power connection	17
5.2.3	Calibration	17

Read this manual carefully before installing and running your system; take particular note of the safety precautions in section 2. Keep the manual in the immediate vicinity of the instrument, so that it can be consulted at any time.

No technical modifications may be made to the instrument without the prior written agreement of BUCHI. Unauthorized modifications may affect system safety or result in accidents. This manual is copyrighted. Information from it may not be reproduced, distributed, or used for competitive purposes, nor made available to third parties. The manufacture of any component with the aid of this manual without prior written agreement is also prohibited.

The English manual is the original language version and serves as basis for all translations into other languages. Other language versions can be downloaded at www.buchi.com.

6	Operation.	18
6.1	Basic operating principles	18
6.1.1	Display during idle.	18
6.1.2	Display during a process or in menus.	19
6.1.3	Entering text	20
6.1.4	Using the external keyboard	20
6.2	Melting point determination	21
6.2.1	Sample preparation	21
6.2.2	Determination without pre-registered melting point method	22
6.2.3	Creating a method.	25
6.2.4	Using and handling methods.	25
6.2.5	Adjusting parameters during a determination	26
6.2.6	Printout	26
6.3	Boiling point	27
6.3.1	Sample preparation	27
6.3.2	Determination without pre-registered boiling point method	27
6.3.3	Creating a method.	29
6.3.4	Adjusting parameters during a determination	29
6.3.5	Printout	30
6.4	Calibration.	31
6.4.1	Calibration principle	31
6.4.2	Calibration procedure	31
6.4.3	Printout	33
6.4.4	User calibration.	34
6.4.5	Verification	34
6.5	Settings, SysInfo, Test	34
6.5.1	Test protocol	36
6.5.2	SysInfo protocol	37
6.6	User management.	38
6.7	XML to PC data export	38
7	Maintenance.	39
7.1	Housing	39
7.2	Glass window	39
7.3	Upkeep.	39
7.4	Cleaning the heating block	39
8	Troubleshooting	41
8.1	Malfunctions and their remedy.	41
8.1.1	Setting the printer baud rate	42
8.2	Customer service.	42
9	Shutdown, storage, transport, and disposal	43
9.1	Storage and transport	43
9.2	Disposal	43
10	Spare parts.	44
11	Declarations and requirements	45
11.1	FCC requirements (for USA and Canada).	45

1 About this manual

This manual describes the Melting Point M-560 and provides all the information required for its safe operation and to maintain it in good working order.

It is addressed in particular to laboratory personnel and operators.

NOTE

The symbols pertaining to safety (WARNINGS and ATTENTIONS) are explained in section 2.

1.1 Reference documents

For more information regarding melting point, refer to the corresponding literature:

- The Laboratory Assistant 94187
- Melting Point M-560, Operating Manual numbers 93251–93255
- Melting Point M-565, Operating Manual numbers 93256–93260

1.2 Abbreviations

Chemicals:

PTFE	Polytetrafluoroethylene
PP	Polypropylene
PE	Polyethylene
EPDM	Ethylene-propylene-diene rubber
POM	Polyoxymethylene
PUR	Polyurethane

Miscellaneous:

mp	Melting point
bp	Boiling point
pharm.	Pharmacopoeia
therm.	Thermodynamic
L	Sample left
C	Sample center
R	Sample right

2 Safety

This section highlights the safety concept of the Melting Point M-560 and contains general rules of behavior and warnings about hazards concerning the use of the product.

The safety of users and personnel can only be ensured if these safety instructions and the safety-related warnings in the individual sections are strictly observed and followed. Therefore the manual must always be available to all persons performing the tasks described herein.

2.1 User qualification

The instrument may be used only by laboratory personnel or other persons whose training or professional experience give them an overview of the dangers which can develop when operating the instrument.

Personnel without this training or persons who are currently being trained require careful supervision. This Operation Manual serves as a basis for training.

2.2 Proper use

The instrument has been designed and built for laboratory use only. It is intended to be used to determine melting and boiling points and melting ranges at ambient temperatures up to 400 °C.

2.3 Improper use

Applications beyond those described above are improper. Furthermore, applications which do not comply with the technical data are also considered improper. The operator bears the sole risk for any damages caused by such improper use.

The following applications in particular are expressly forbidden:

- Use in rooms requiring explosion-proof equipment.
- Extraction of samples which may explode or ignite as the result of a blow, friction, heat, or spark (e.g. explosives).

2.4 Warning notices used in this manual



WARNING

Generally, the triangular warning symbol indicates the possibility of personal injury or even loss of life if the instructions are not followed.



WARNING

Hot surface.



WARNING

Electrical hazard.



WARNING

Biohazard.



ATTENTION

The "read this" symbol for ATTENTION indicates that equipment damage, malfunctions, or incorrect processes may result if the instructions are not followed.

NOTE

Useful tips to facilitate operation of the instrument.

2.5 Product safety

The Melting Point M-560 is designed and built in accordance with current state-of-the-art technology. However, risks to users, property, and the environment can arise when the instrument is used carelessly or improperly.

The manufacturer has determined residual dangers emanating from the instrument

- if the instrument is operated by insufficiently trained personnel.
- if the instrument is not operated properly.

Appropriate warnings in this manual serve to alert the user to these residual dangers.

2.5.1 Instrument-related hazards

Pay attention to the following safety notices:



WARNING

Potentially hot surfaces during operation, especially the heating oven (up to 400 °C).

- Always be aware of the danger of being burned.

2.5.2 Other hazards



WARNING

Certain solvents within or in the vicinity of the Melting Point M-560 can form peroxides and/or are highly inflammable.

- Always be aware of the explosion risk when working with hazardous substances or with substances of unknown composition.
- Always use the instrument in an adequately ventilated work area.

2.5.3 Safety measures



Always wear personal protective equipment such as protective goggles and protective clothing, when working with the instrument.



2.5.4 Safety elements

Anti-seismic tie-down

- The instrument is equipped with a fixture to tie it down in areas at risk of an earthquake (see bottom side of the instrument).

2.6 General safety rules

Responsibility of the operator

The head of laboratory is responsible for training the lab personnel.

The operator shall inform the manufacturer without delay of any safety-related incidents that occur during the operation of the instrument. Legal regulations, such as local, state, and federal laws applying to the instrument, must be strictly followed.

Duty of maintenance and care

The operator is responsible for ensuring that the instrument is operated only in a proper manner and that maintenance, service, and repairs are performed with care, on schedule, and by authorized personnel only.

Spare parts to be used

Use only recommended consumables and spare parts for maintenance in order to ensure continued optimum system performance and reliability. Modifications to the spare parts used are allowed only with the prior written permission of the manufacturer.

Modifications

Modifications to the instrument are permitted only after prior consultation with and written approval from the manufacturer. Modifications and upgrades should be carried out only by an authorized BUCHI technical engineer. The manufacturer reserves the right to decline any claim resulting from unauthorized modifications.

3 Technical data

This section introduces the reader to the Melting Point M-560 and its main components. It contains technical data, requirements and performance data.

3.1 Scope of delivery

Check the scope of delivery according to the order number.

NOTE

For detailed information on the listed products, see www.buchi.com or contact your local dealer.

3.1.1 Standard accessories

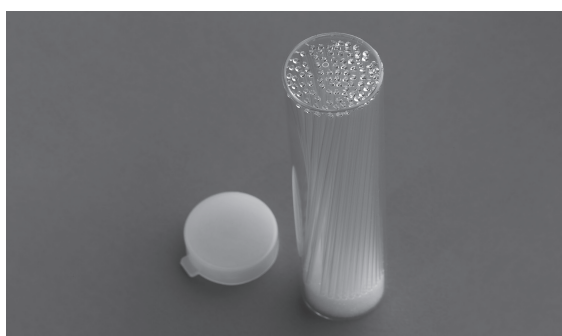
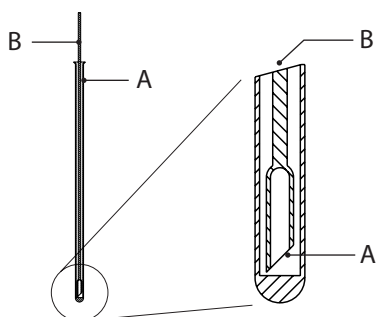
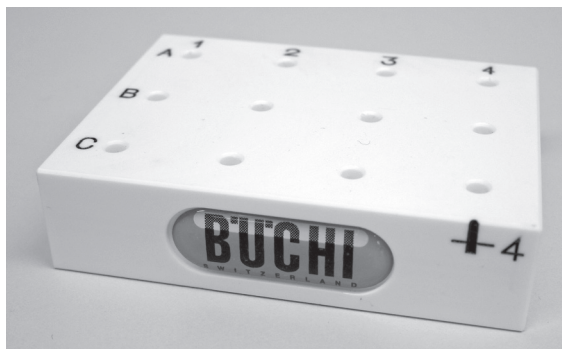

Table 3-1: Standard accessories

Product	Ordernumber
Melting Point M-560	051999
Calibration set M-560/M-565 (4 substances; 4-nitrotoluene, diphenyl acetic acid, caffeine, potassium nitrate)	11055018
Melting point capillaries, 100 units	017808

**Table 3-1: Standard accessories (cont.)**

Product	Ordernumber
Sample holder	11055014
Cleaning tool	051978
A) Boiling point tubes, 10 units	019697
B) Boiling point capillaries, 10 units	051850

3.1.2 Optional accessories

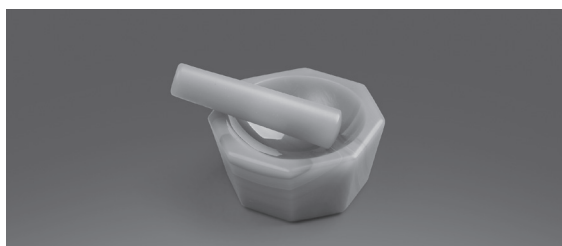
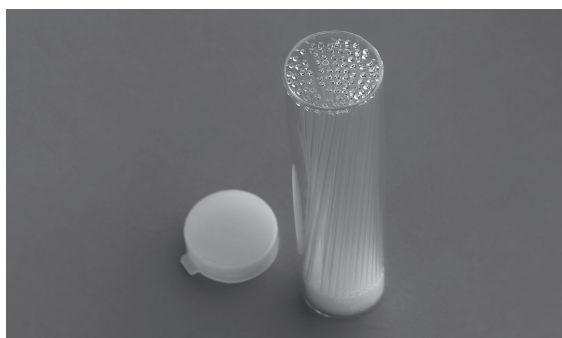
**Table 3-2: Optional accessories**

Product	Ordernumber
Sample Loader M-569	051997
Verification set M-560/M-565 (3 substances; benzil, p-anisic acid, phenolphthalein)	11055019
Melting point capillaries, 1000 units	001759
Mortar and pestle, agate	041867
Compact keyboard German (CH)	029509
Compact keyboard English (USA)	029508
Serial dot matrix printer (including ribbon, paper roll, and cables)	11069766

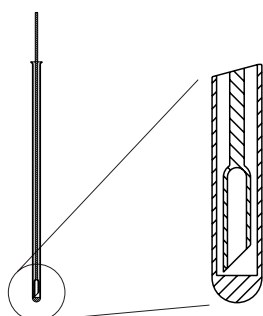
**Table 3-2: Optional accessories (cont.)**

Product	Ordernumber
Ribbon for printer SP512	044306
Ribbon for printer SP712	11069767
Paper roll for printer	038684
A) Boiling point tubes, 100 units	019007
B) Boiling point capillaries, 100 units	051890
Protective cover	051935
User management activation code	11066387
Compaction wire	036721

3.2 Technical data overview

Table 3-4: Technical data of the Melting Point M-560

	Melting Point M-560
Manual melting point determination	√
Manual boiling point determination	√
Automatic melting point determination	–
Automatic boiling point determination	–
Homogeneous sample loading	–
Positions for melting capillaries	3
Positions for boiling capillaries	1
Precision magnifying lens	√
Magnification of lens	2.5×
Display	Colour, TFT, 320×240, 3.5"
Determination temperature range	Ambient +10 °C to 400 °C
Temperature resolution	0.1 °C

Table 3-4: Technical data of the Melting Point M-560

Melting Point M-560	
Accuracy of melting point at 0.5 °C/min	±0.2 °C
Repeatability of melting point at 0.5 °C/min	±0.1 °C
Accuracy of boiling point at 1.0 °C/min up to 400 °C	±0.5 °C
Repeatability of boiling point at 1.0 °C/min	±0.3 °C
Temperature gradients, °C/min	0.1, 0.2, 0.5, 1, 1.5, 2, 2.5, 3, 5, 10, 20
Heat-up time (50 °C–350 °C) at 25 °C	~4 min
Cool-down time (350 °C–50 °C) at 25 °C	~13 min
Electrical supply	100–240 V (±10 %), 50–60 Hz
Power consumption	150 W
Contact termination	L, N, PE
Approval	CE, CSA, UL
Dimensions (W×H×D), mm	190×200×370
Weight, kg	4.5
Environmental conditions	For indoor use only
Temperature	5–40 °C
Altitude	up to 2000 m a.s.l.
Humidity	Maximum relative humidity 80% for temperatures up to 31°C, decreasing linearly to 50% relative humidity at 40°C
Overvoltage category	II
Degree of protection	IP20
Pollution degree	2
Storable methods for melting point	50
Storable methods for boiling point	50
Compliant with Pharmacopoeia methods	PH. EUR., USP and JP

NOTE

Temperature measuring accuracy refers to pharmacopoeia melting point.

3.3 Materials used

Table 3-5: Materials used

Component	Material designation
Print holder	PA
Heating block	Aluminium
Lenses	Glass
Axial fan	Aluminium
Housing	PU, Stainless Steel, Glass
Cover	POM, Ceramic, Aluminium, Stainless Steel

4 Description of function

This section explains the basic principle of the Melting Point M-560 and provides a functional description of the assemblies.

4.1 Melting Point

The Melting Point M-560 is an instrument for manual (visual) determination of melting point, melting range, and boiling point at ambient temperatures +10 °C up to 400 °C. The melting point of three samples can be determined at the same time. The boiling point can be determined for one sample. Samples have to be observed through the lens.

The melting point capillary sits in a hollow of the metal block, which is heated electrically and controlled by a temperature sensor. The heating block is capable of being maintained accurately at a pre-defined temperature by the heating element, and of being heated at a defined rate.

4.2 Boiling Point

The boiling point is determined by the "Siwoloboff" method.

The Melting Point M-560 can be used to determine the boiling point of a small amount of liquid. The heating block has one insert available for boiling point tubes (outside left). The moment of boiling is determined visually.

The process for boiling point determination is analogous to that for determining a melting point:

- The start temperature is set 5 to 10 °C lower than the expected boiling point.
- The sample is put into the heating block as soon as the start temperature is reached.
- A delay time allows the equilibrium between oven temperature and sample temperature. During this delay time some air bubbles escape from the boiling point capillary.
- Starting from the start temperature, the sample is heated at a temperature gradient of 1 °C/min.
- As the temperature rises, bubbles of gas rise slowly and regularly from the immersed end of the boiling point capillary.
- The boiling point of the liquid has been reached when the flow of steam bubbles reaches a frequency of 0.6 Hz [Hertz].

4.3 Controls and connections



- ① Power switch; turns the instrument on/off
- ② Start; starts process
- ③ Stop; stops process, starts/stops ventilation, returns to idle screen
- ④ 3 Select and Set buttons
- ⑤ Rotary knob for navigation through the menu and for select characters
- ⑥ Display

Fig. 4.1: Front view

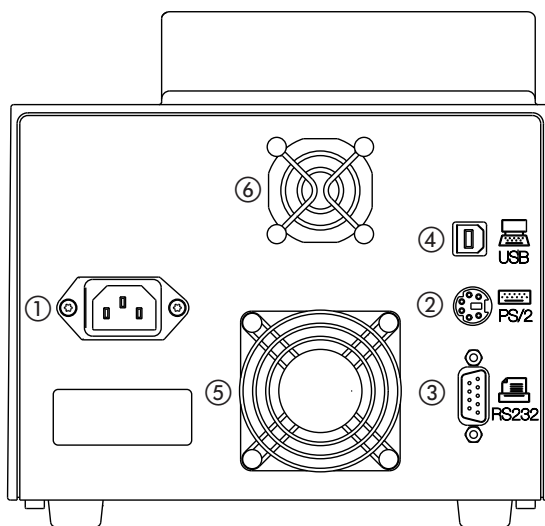

- ① Mains plug
- ② PS/2 connection for keyboard
- ③ RS 232 connection for serial printer
- ④ USB connection: required for service
- ⑤ Housing cooling fan
- ⑥ Heating block cooling fan

Fig. 4.2: Rear view

5 Putting into operation

This section describes the installation of the Melting Point M-560 and gives instructions for initial start-up.

NOTE

Inspect the instrument for damage during unpacking. If necessary, prepare a status report immediately to inform the postal company, railway company, or transport company. Keep the original packaging for future transport.

5.1 Installation site

Place the instrument on a stable, horizontal surface adequate for the maximum product dimensions. It is advisable to place the instrument in a fume hood due to the fact that it will be used to measure chemical substances. For safety reasons and to ensure sufficient cooling in the electronic compartment, the unit must be placed at least 30 cm away from rear walls or other objects. No containers, chemicals, or other appliances should be placed behind the unit.

General hazards arise from:

- Mixtures of unknown composition or contaminations
- Combustible gases or solvent vapor in the immediate vicinity of the unit
- Damaged glass components
- Insufficient distance from back of the unit to the wall
- Burning by touching hot parts of the heater

5.2 Commissioning

5.2.1 Unpacking and installation

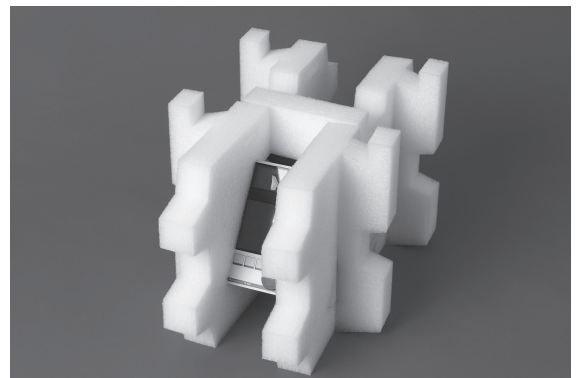
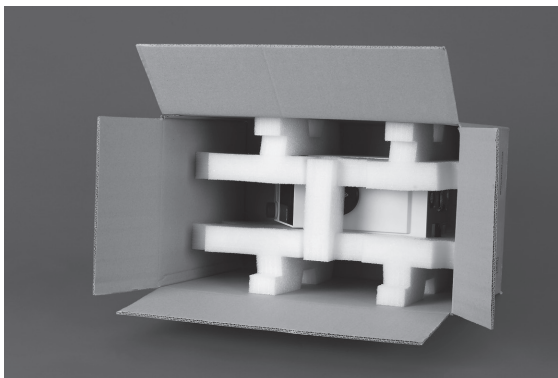

- Unpack the instrument and place it on a table. Remove the packing, and make sure that the following parts are installed:



- Glass window

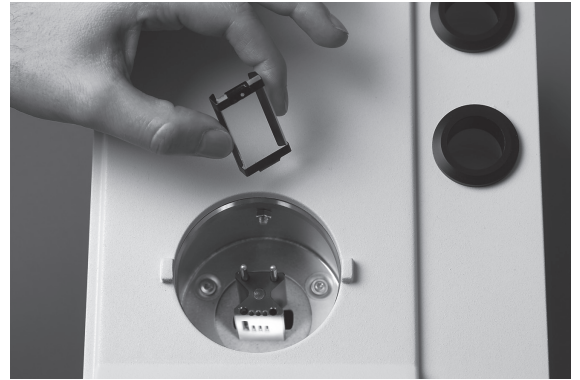

- Glass window with glass holder



- Install the glass window with glass holder on the front side of the heating block.
- Press the glass holder down.



- Install the cover.

Accessories

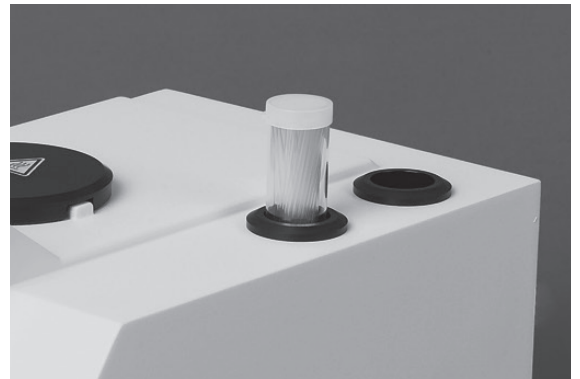

- Place the melting point capillaries in the hole of the housing. The second hole is a reservoir for used capillaries.

5.2.2 Power connection



ATTENTION

Make sure that the voltage of the socket corresponds to the voltage given on the type plate of the instrument. Ensure that the instrument is grounded. External connections and extension cables must be provided with a grounded conductor lead (3-pole couplings, cable, or plug equipment) as the mains lead has a molded plug to avoid risks due to inadvertently defective wiring. Make sure that no electric sparks form in the instrument or its surroundings as they may damage the instrument. Make sure that the mains connector is freely accessible at any time.

5.2.3 Calibration

NOTE

Before use it is recommended to calibrate the apparatus. Use supplied calibration substances only. Calibration is carried out in accordance with section 6.4 of these operating instructions.

6 Operation

This section explains the operating elements and possible operating modes. It gives instructions on how to operate the Melting Point M-560 properly and safely.

ATTENTION



Before use it is recommended to calibrate the apparatus. Use supplied calibration substances only. The calibration mode is described in section [6.4 Calibration].

6.1 Basic operating principles



WARNING

The heating oven can reach temperatures of up to 400 °C.

6.1.1 Display during idle

After switching on, the display shows the menu for melting point.

① Function category with main setting parameters

② Advice

③ Parameters used after pressing START

④ Shows current heating block temperature and time

⑤ Functions selectable by the keys below

Different menus can be accessed by turning the rotary knob. Each menu has its own symbol. These idle screens are the starting points for all actions. The corresponding symbol is displayed during all processes.

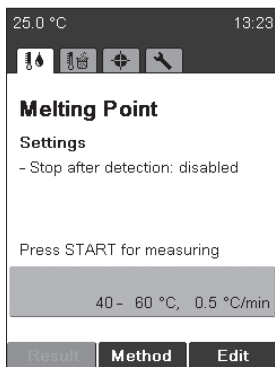

Melting Point

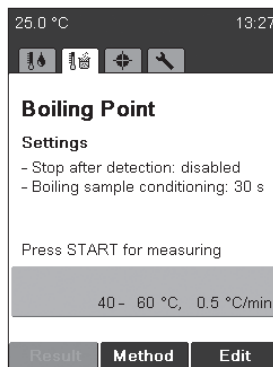

Boiling Point

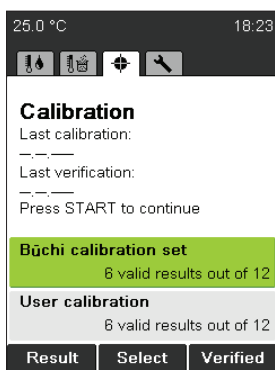

Calibration

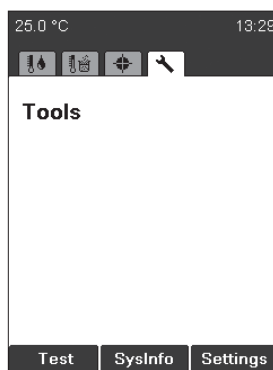

Tools

6.1.2 Display during a process or in menus

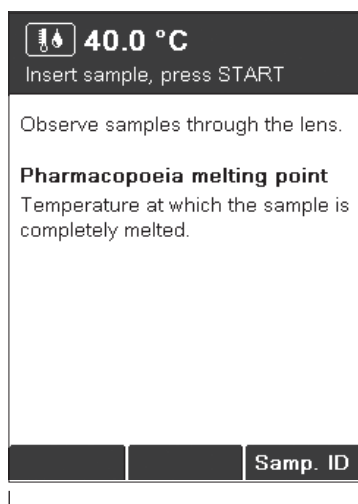

- ①
- ②

- ① Shows where you are and gives advice and instructions.
- ② Working area shows:
 - items to select
 - samples during measurement
 - specific information in connection with the current menu
- ③ Functions selectable by the keys below.

- ③

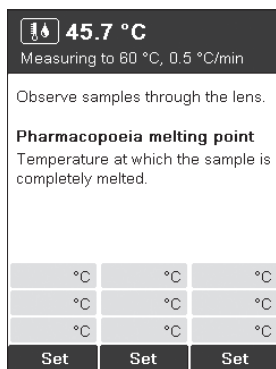

Screen during melting point determination

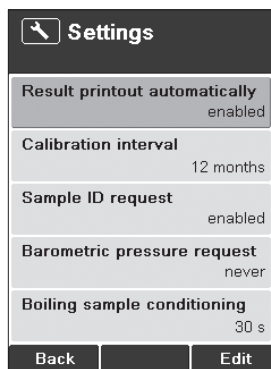

Settings menu

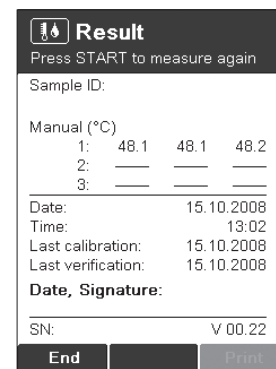

Result indication (numeric result)

6.1.3 Entering text



Text can be entered by using the rotary knob, an external keyboard.

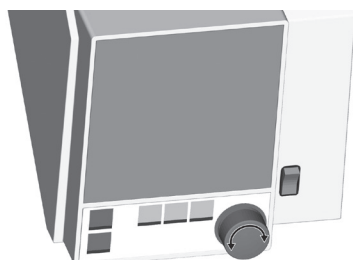

Rotary knob:

- Turn the rotary knob to select a character and press Enter. Press Save after entering all characters.

6.1.4 Using the external keyboard

NOTE

The instrument can be operated using an external keyboard.

For the softkeys, the following keys of the external keyboard are assigned:

- ENTER = right softkey
- Alt = center softkey
- Esc = left softkey
- In the method menu: To navigate quickly to a method name press the initial letter.

6.2 Melting point determination

NOTE

For exact melting point determination, use original capillaries from BUCHI only. If other capillaries are used, the results may be inaccurate. Use the following items:

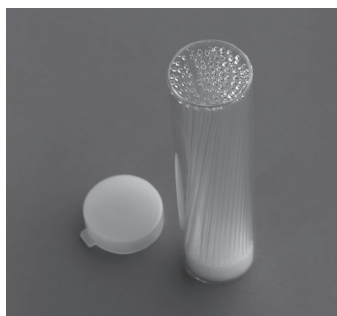

Fig. 6.1: Melting point capillaries

Product	Order number
Melting point capillaries, 100 units	017808
Melting point capillaries, 1000 units	001759

6.2.1 Sample preparation

NOTE

Use only capillaries from BUCHI. They are precise and adequate for this kind of operation. Other capillaries have other dimensions and wall thicknesses. Using others may result in results that are incorrect.

Each sample has to be prepared.

The following methods to compact the samples are recommended:

- Using the Sample Loader M-569
- Knocking the capillaries on a hard surface.

NOTE

Sample preparation by letting the capillaries fall through a tube is not advised, because cross contamination may occur.

Preparation of the samples:

- The samples being investigated must be fully dry, homogenous and in powdered form. Moist samples must be dried first (the pharmacopoeias prescribe that the substance needs to be dried in a vacuum for 24 hours over silica gel R). Coarse crystalline samples and non-homogeneous samples are finely ground in a mortar.
- To fill the capillary tubes with the sample, the open ends of the tubes are pressed into the substance. The substance is moved to the bottom of the tubes by repeatedly tapping the tubes against a hard base.
- Enough substance must be filled into the glass capillary to form a compact column 4–6 mm in height. (A height of 4–5 mm is recommended for precision measurements.) To ensure comparable results, it is important to fill all three capillary tubes to the same height and to compact the substance well in the tubes using the Sample Loader M-569.

6.2.2 Determination without pre-registered melting point method

- Choose the menu for melting point determination.
- Make sure that all samples are removed.
- Press START to begin the determination process immediately with the last parameters used. They always remain saved in the instrument and are indicated in the green field in the lower part of the screen.

NOTE

If the current parameters do not meet your requirements, press Edit and set start temperature, stop temperature, and temperature gradient.

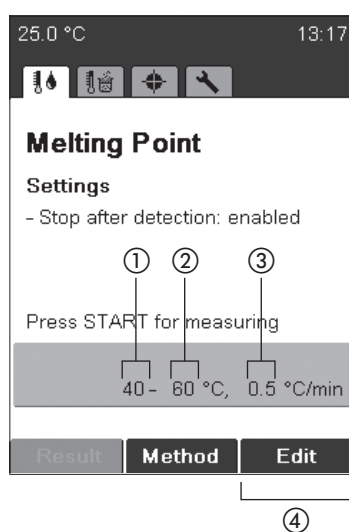

- ① Start temperature
- ② Stop temperature
- ③ Temperature gradient
- ④ Edit

- To adjust the desired melting parameters, press Edit.

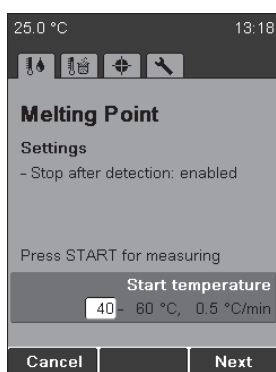

- Chose start temperature with the rotary knob, and press Next.

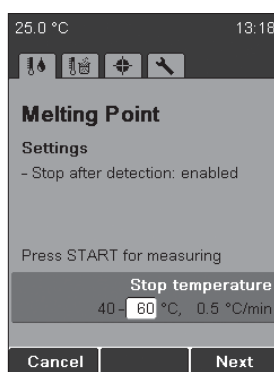

- Chose stop temperature with the rotary knob, and press Next.

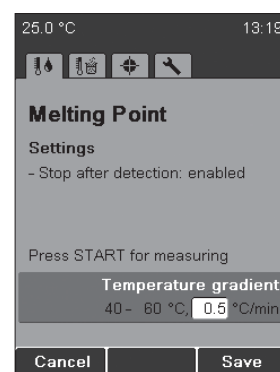

- Chose temperature gradient with the rotary knob, and press Save.

NOTE

Insert samples only when the start temperature is reached (as soon as prompted).

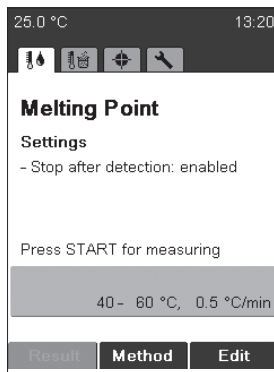

- Press START to begin the determination, and follow the on-screen instructions.

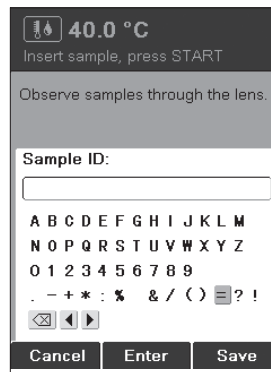

- The instrument requests a sample ID during preheating (for details on entering text see 6.1.3). This request can be switched off by changing the setting "Sample ID request" (see 6.5).

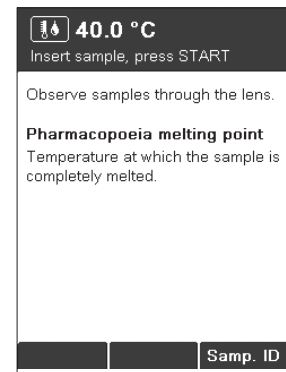

- Insert samples and press START to begin the determination.

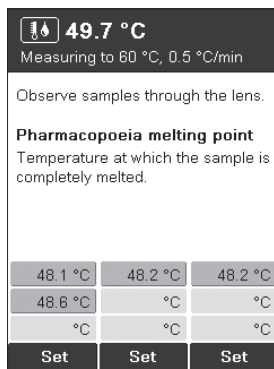

- To register additional temperature stamps, manually press the SET button for the related sample. Each button can be pressed three times. Registered temperature stamps are displayed in green.

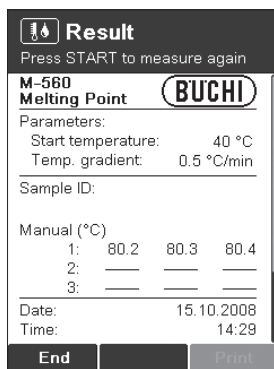

- To run through the result, turn the rotary knob up and down.
- Press End or STOP to return to the idle screen.
- Press START to measure again with the identical measuring parameters.
- The result is printed out automatically if a printer is connected.

NOTE

The last result is stored in the device until a new measurement is started or the instrument is switched off.

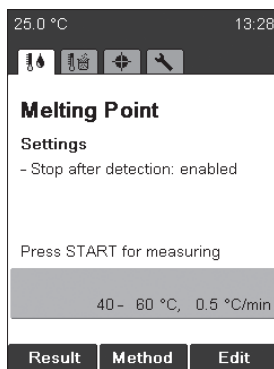

- After turning back to idle, the last result can be checked again by pressing Result.

6.2.3 Creating a method

Instead of entering and using the parameters directly from the idle screen, it is also possible to store parameter sets as methods.

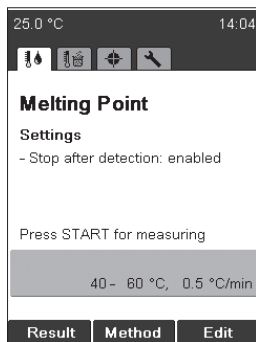

- To enter the method menu, press Method.



- To create a new method, press Options → New then OK.



- Enter a method name. To finish press Save.



- Adjust a parameter and press Next. Then Save.

6.2.4 Using and handling methods

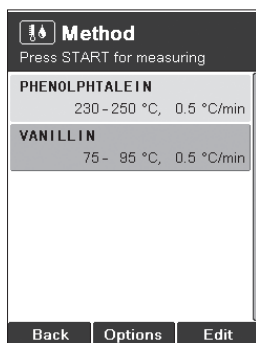

- Turn the rotary knob to select a method.
- Press START to start the determination.
- Use Edit to adjust method parameters.
- Press the Options key to access further functions:
 - New: Creates a new method.
 - Delete: Deletes the method.
 - Rename: Changes the method name.

NOTE FOR USER MANAGEMENT

Methods can only be started in the user level. All other actions are not possible.

6.2.5 Adjusting parameters during a determination

NOTE

Measuring parameters can be modified during preheating or a determination. This function is possible only if enabled by the setting "Param. adj. during meas." (see 6.5).

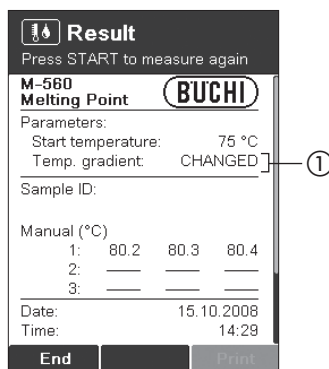
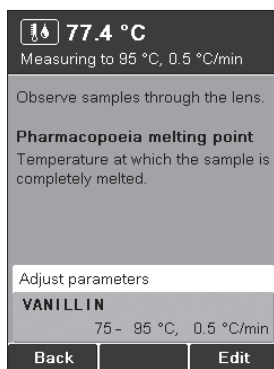

- Turn the rotary knob to display the current parameter set.
- Adjust the parameters by pressing Edit. Adjusting the parameters does not affect the saved method.
- If the temperature gradient is changed during a measurement, the result shows CHANGED (①) for the temperature gradient.

6.2.6 Printout

NOTE

The result is printed out if a printer is connected.

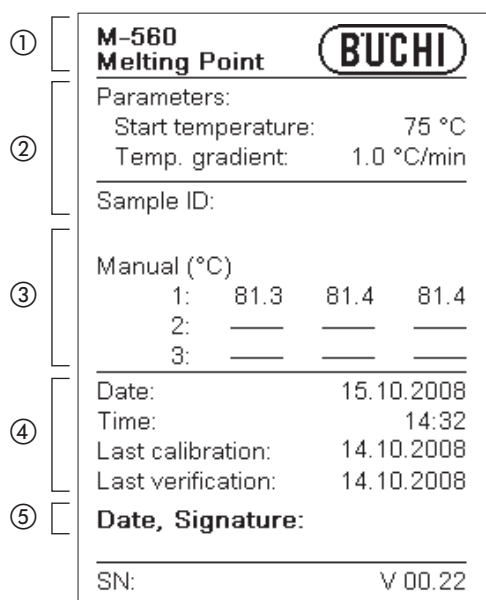

Printout

- ① Instrument type
- ② Determination parameters
- ③ Manual pressed results
- ④ General information
- ⑤ Signature of person making the determination

6.3 Boiling point

NOTE

For exact boiling point determination, use boiling point tubes and capillaries from BUCHI only. If other glass parts are used, incorrect or no results may be obtained. Use the following items:

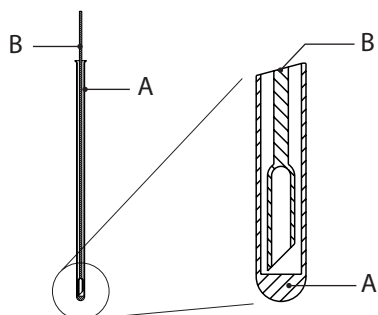

Fig. 6.2: Boiling point tube and capillary

Product	Order number
A) Boiling point tubes, 10 units	019697
A) Boiling point tubes, 100 units	019007
B) Boiling point capillaries, 10 units	051850
B) Boiling point capillaries, 100 units	051890

6.3.1 Sample preparation

In preparation, the boiling point tubes are filled with 5 to 10 mm of liquid sample. We recommend using a syringe for simple filling. Insert a boiling point capillary into the boiling point tube with its open/thick end down. Put the sample immediately into the heating block.

6.3.2 Determination without pre-registered boiling point method

- Choose the menu for boiling point determination.
- Make sure that all samples are removed.
- Press START to begin the determination process immediately with the last parameters used. They are always saved in the instrument and are indicated in the green field in the lower part of the screen.

If the current parameters do not meet your needs, press Edit and set the start temperature, stop temperature, and temperature gradient.

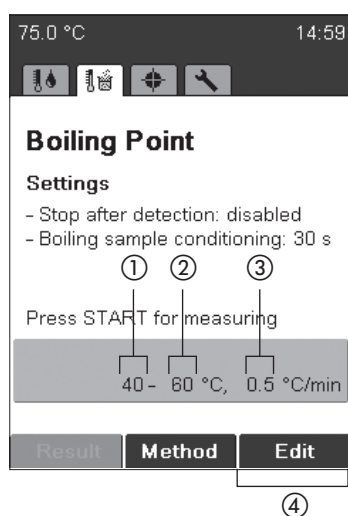

- ① Start temperature
- ② Stop temperature
- ③ Temperature gradient
- ④ Edit

- To adjust the boiling parameters, press Edit.

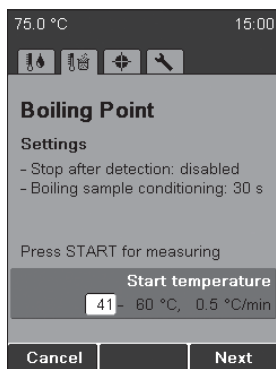

- Use the rotary knob to choose the start temperature and press Next.

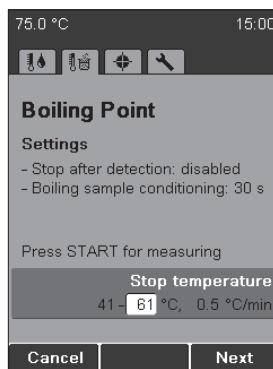

- Use the rotary knob to choose the stop temperature and press Next.

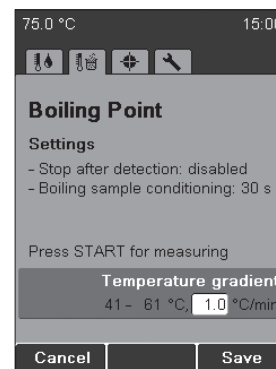

- Use the rotary knob to choose the temperature gradient and press Save.

NOTE

Insert sample only when the instrument has reached the start temperature.

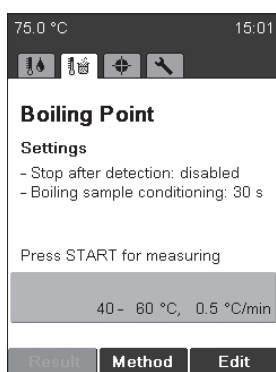

- Press START to begin the determination and follow the instructions on the screen.



- The instrument requests a sample ID during preheating (for details on entering text see 6.1.3). This request can be switched off by changing the setting "Sample ID request" (see 6.5).

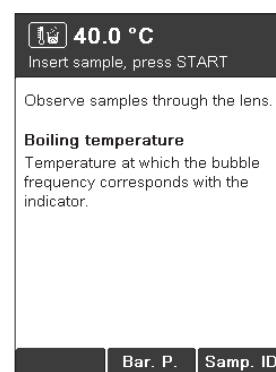

- Bar P: Enter the current barometric pressure.
- This request can be switched off by changing the setting "Barometric pressure request" (see 6.5).
- Insert sample and press START to begin the determination.

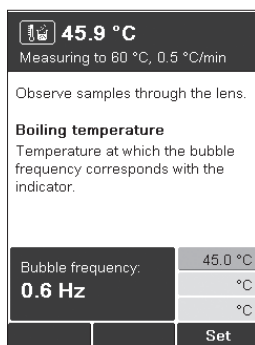

- Delay: to ensure equilibrium between oven temperature and sample temperature. During this delay time some air bubbles escape from the boiling point capillary. This request can be changed in the setting “Boiling sample conditioning” (see 6.5). Bubble frequency is an indicator. When frequency of air bubbles coming out of the capillary is equal the indicator press Set.

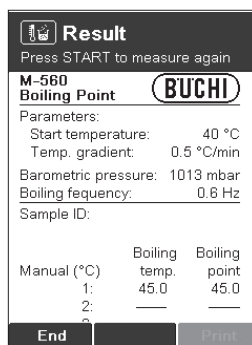

- To run through the result, turn the rotary knob up and down.
- Press End or STOP to return to the idle screen.
- Press START to measure again with the identical measuring parameters.

6.3.3 Creating a method

NOTE

The process of creating a boiling point method is identical that used to create a melting point method (see 6.2.3).

6.3.4 Adjusting parameters during a determination

During preheating or a determination, measuring parameters can be modified. This function is possible only if enabled by the setting “Param. adj. during meas.” (see 6.5).

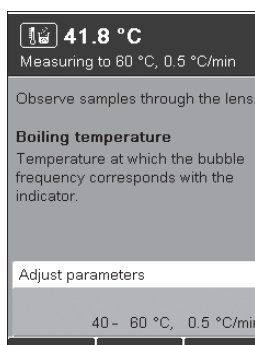

- Turning the rotary knob displays the current parameter set.
- Adjust the parameters by pressing Edit. Adjusting the parameters does not affect the saved method.

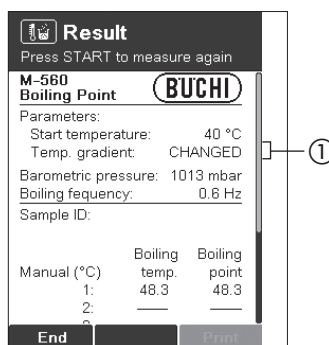

- If the temperature gradient is changed during a measurement, the result shows CHANGED (①) for the temperature gradient.

When a measurement is completed, the last method parameters are always retained in the instrument. To start the same method, just press START.

NOTE

Results are stored in memory until a new measurement is started or the instrument is switched off.

6.3.5 Printout

①	M-560	BUCHI	
	Boiling Point		
	Parameters:		
	Start temperature:	75 °C	
	Temp. gradient:	1.0 °C/min	
②	Barometric pressure:	1013 mbar	
	Boiling frequency:	0.6 Hz	
	Sample ID:		
③	Manual (°C)	Boiling temp.	Boiling point
	1:	80.2	80.2
	2:	—	—
	3:	—	—
	Date:		15.10.2008
	Time:		15:47
④	Last calibration:		14.10.2008
	Last verification:		14.10.2008
⑤	Date, Signature:		
	SN:		V 00.22

Printout

- ① Instrument type
- ② Determination parameters
- ③ Manual pressed results
- ④ General information
- ⑤ Signature of person making the determination

Boiling temp.= Temperature sample boiled.

Boiling point= Boiling temp. corrected according entered barometric pressure.
If a barometric pressure of 1013 mbar is entered boiling temperature and boiling point results are equal.

6.4 Calibration

NOTE

BUCHI recommends calibrating each new instrument after installation. Furthermore it is recommended that the instrument be recalibrated every year.

Two calibration modes are available: with BUCHI substances and user defined substances

6.4.1 Calibration principle

NOTE

The instrument is calibrated using melting point standards. The calibration is valid for boiling points as well. The calibration procedure is recommended to be performed with the BUCHI calibration substances, in the BUCHI calibration set mode.

Use the calibration set (11055018). This calibration set contains the melting point standards listed below. Each standard is shipped with a certificate of analysis and an MSDS (material safety data sheet).

The calibration set contains the following substances:

- 4-Nitrotoluene: approx. 52 °C
- Diphenyl acetic acid: approx. 148 °C
- Caffeine: approx. 237 °C
- Potassium nitrate: approx. 335 °C

From each substance, a minimum of 6 have to fulfill a standard deviation of less than +/- 0.2 °C. Otherwise the instrument will not move on to the next substance. The maximum number of samples for each substance to reach the deviation of +/- 0.2 °C is limited to 12 samples. The instrument automatically chooses the best 6 results from the determinations performed.

After a successful calibration is done, it may be checked using the verification set (11055019). Each standard of the set contains a certificate of analysis and the MSDS.

The verification set contains the following substances:

- Benzil: approx. 94 °C
- p-Anisic acid: approx. 182 °C
- Phenolphthalein: approx. 261 °C

NOTE FOR USER MANAGEMENT

The calibration procedure can only be performed in the administrator level.

6.4.2 Calibration procedure

To start calibration, turn the rotary knob to Calibration. Press START and follow the instruction on display.

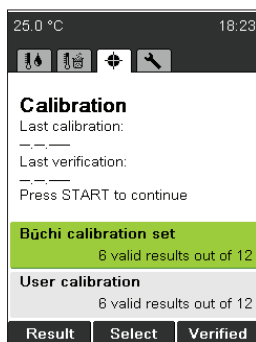

- The instrument automatically heats to the start temperature of the first substance. In the meantime, prepare at least 6 samples of the given substance. For this process, follow section 6.2.1.

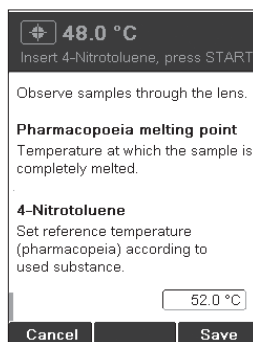

- Choose the correct pharmacopoeia melting point value with the rotary knob. The pharmacopoeia melting point is written on the certificate of analysis. Press Save.

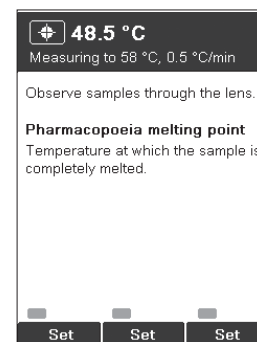

- To register temperature stamps manually press the Set button for the related sample. Each button can be pressed once. Registered temperature stamps are displayed green.

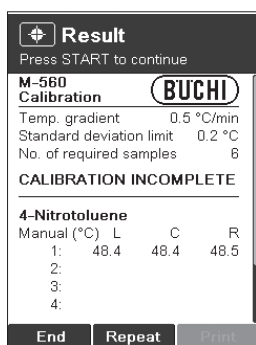

After each run the current result is indicated.

- Press START to perform next measurement.

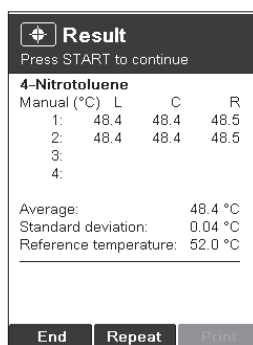

After 6 results are obtained within a standard deviation of +/- 0.2 °C, the process moves on to the next substance. The process is identical for the subsequent substances.

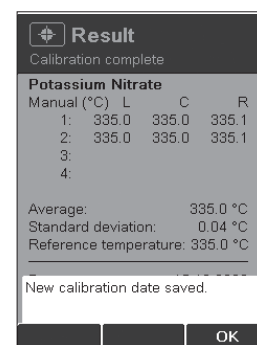

As soon as a complete calibration is obtained, the new calibration date is saved automatically.

- Press OK. All results obtained are displayed.

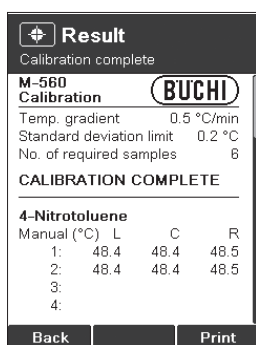

- The rotary knob can be used to display all the results of the calibration.
- The Print key is used to print out the data.
- Back exits this menu.

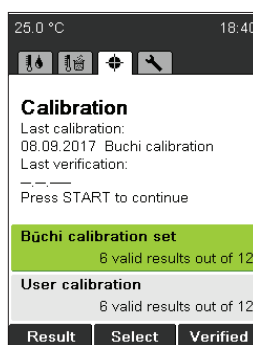

The calibration date is now saved and indicated on the idle screen.

6.4.3 Printout

M-560		BUCHI	
Calibration			
Temp. gradient	0.5 °C/min		
Standard deviation limit	0.2 °C		
No. of required samples	8		
CALIBRATION COMPLETE			
4-Nitrotoluene			
Auto (°C)	L	C	R
1:	52.0	52.1	52.1
2:	52.1	52.0	52.0
3:			
4:			
Average:	52.1 °C		
Standard deviation:	0.05 °C		
Reference temperature:	52.0 °C		
Diphenylacetic Acid			
Auto (°C)	L	C	R
1:	147.5	147.5	147.5
2:	147.7	147.6	147.5
3:			
4:			
Average:	147.6 °C		
Standard deviation:	0.08 °C		
Reference temperature:	147.6 °C		
Caffeine			
Auto (°C)	L	C	R
1:	236.8	236.9	236.7
2:	236.8	236.8	236.7
3:			
4:			
Average:	236.8 °C		
Standard deviation:	0.08 °C		
Reference temperature:	236.8 °C		
Potassium Nitrate			
Auto (°C)	L	C	R
1:	334.5	334.6	334.6
2:	334.6	334.4	334.7
3:			
4:			
Average:	334.6 °C		
Standard deviation:	0.10 °C		
Reference temperature:	334.5 °C		
Date:	09.10.2008		
Time:	11:18		
Date, Signature:			
SN:	V 00.22		

Printout

- ① Instrument type
- ② General information regarding calibration
- ③ Results 4-nitrotoluene
- ④ Results diphenylacetic acid
- ⑤ Results caffeine
- ⑥ Results potassium nitrate
- ⑦ General information
- ⑧ Signature of person performing the calibration

NOTE

The Average is calculated on the basis of the temperature values with two positions after the decimal point. Thus, the value indicated for the Average might deviate from the value you calculate on the basis of the temperature values on the printout, as there is just one position after the decimal point.

6.4.4 User calibration

A user calibration can be performed with any four substances at any heating ramp. Therefore the procedure described in 6.4.2 can be performed with the user calibration mode.

6.4.5 Verification

To verify the calibration, proceed as follows:

- Measure all standards (BUCHI recommends using the verification set (11055019) but it is also possible to use your internal standards.

NOTE

The verification is not a guided process.

- When all measuring results were within the required tolerances, click on Verified. The following screen appears:

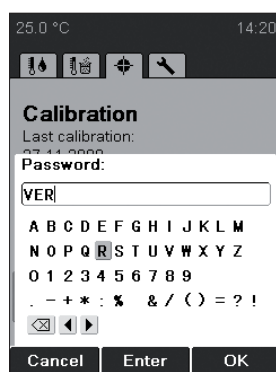

- Enter the following password: VER. The current date is now indicated under "Last verification".

6.5 Settings, SysInfo, Test

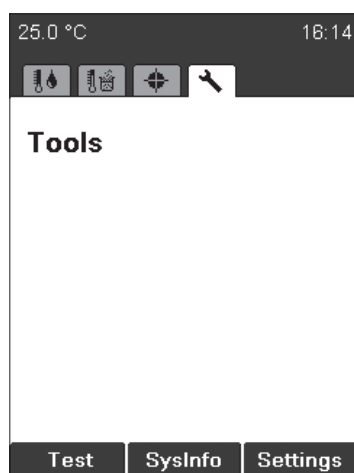

Test: Functional test of the instrument. To perform the test of several functions follow carefully the on-screen instructions. If a function test does not show ok, please contact the customer service. The Test protocol is described in section 6.5.1.

SysInfo: Instrument gives information regarding settings and connected devices. The SysInfo protocol is described in section 6.5.2.

Settings: This menu can be used to change parameters.

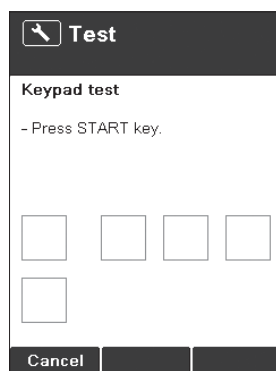

- Press the Test button to enter the functional test, and follow the instructions.

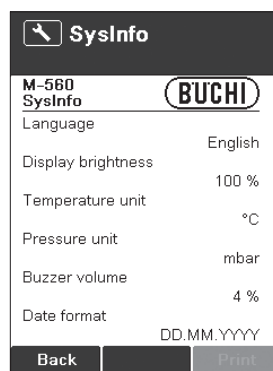

- Press the SysInfo button to open the system information menu.

Printout is possible if a printer is connected.

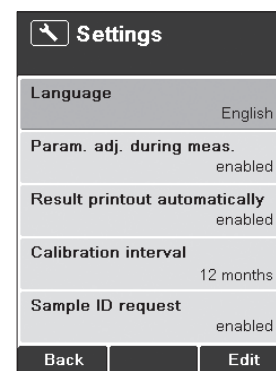

- Press the Settings button to enter the settings menu.

Table 6-1: Setting parameters

Language	English, German, French, Italian, Spanish, Japanese, Chinese
Param. adj. during meas.	disabled,enabled:Whetherornotitispossibletochangeparameters (start temperature, stop temperature and temperature gradient) during a determination.
Calibration interval	0–36 months: default 12 months. BUCHI recommends calibration or verification after 12 months using the calibration set and the verification set.
Sample ID request	enabled: After the start of determination, the sample ID window is displayed. disabled: The sample ID window is not automatically displayed. In combination with the Melting Point Monitor software, it is advisable to turn this feature off.
Barometric pressure request	Has impact only on boiling point determination. never: No pop-up screen is shown. daily: Enter current barometric pressure once a day. always: Enter current barometric pressure every time the instrument heats up to the start temperature for boiling point determination.
Boiling sample conditioning	0–600 s: The default value is set to 60 seconds. This is needed to ensure temperature equilibrium between heating block and liquid in the boiling point tube. If this value is set too low, the result can be incorrect or no automatic boiling point detection.
Company name	The name of a company can be entered.
Date (DD.MM.YYYY)	XX.XX.XXXX
Time (24 h)	XX:XX
Date format	DD.MM.YYY, MM/DD/YYYY, YYYY-MM-DD
Time format	24 h, AM/PM
Temperature unit	°C, °F, K
Pressure unit	hPa, mbar, Torr, mmHg

Table 6-1: Setting parameters

Buzzer volume	0, 1, 2, 3, 4
External Keyboard	CH, USA
Display brightness	0–100 %
User management	Activation key will enable the user management setting. After an administrator password can be defined. The instrument can only be started in the administrator mode if the correct password is entered.

6.5.1 Test protocol

M-560		BUCHI
Test Result		
①	Keypad	OK
	Rotary knob	OK
	24V input voltage	OK
	24V after fuse	OK
	5V	OK
	Heating present	OK
	Cooling fan present	OK
	Housing fan present	OK
	Temp. sensor present	OK
	Temp. sensor function	OK
	External keyboard	OK
	Board temp. sensor	OK
	Heating function	OK
	Cooling fan	OK
	Housing fan	OK
	Sample illumination	OK
	Internal clock	OK
Display	OK	
②	Date, Signature:	
	SN:	V 01.05

① Power supply voltage

② Signature of person carrying out the test

6.5.2 SysInfo protocol

M-560		BUCHI	
SysInfo			
Settings			
Language	English		
Param. adjust. during meas.	enabled		
Calibration interval	12 Months		
Sample ID request	disabled		
Barometric pressure request	always		
Boiling sample conditioning	30 s		
Company name			
Date (DD.MM.YYYY)	12.01.2010		
Time (24 h)	08:03		
Date format	DD.MM.YYYY		
Time format	24 h		
Temperature unit	°C		
Pressure unit	mbar		
Buzzer volume	4		
External keyboard	CH		
Display brightness	100 %		
Service			
Serial number			
Firmware version	01.05.11		
Version CPLD	00.15		
Operating hours	576393.1 h		
No. of melting point meas.	97		
No. of boiling point meas.	22		
Number of calibrations	14		
Calibration date	20.03.2009		
Verification date	18.02.2009		
Factory adj. value at 20°C	3.56 °C		
Calibration value at 52°C	3.54 °C		
Calibration value at 148°C	3.47 °C		
Calibration value at 237°C	4.52 °C		
Calibration value at 335 °C	4.55 °C		
Factory adj. value at 400°C	4.57 °C		
Sample illumin. brightness	100 %		
Board test date	---		
End test date	---		
Board temperature	42 °C		
Heating present	OK		
Cooling fan present	OK		
Housing fan present	OK		
Temp. sensor present	OK		
Temp. sensor function	OK		
24V before fuse present	OK		
24V after fuse present	OK		
5V present	OK		
Date, Signature:			
SN:	V 01.05		

- ① Setting parameters
- ② Calibration correction values
- ③ Date of factory tests

6.6 User management

An optional user management (11066387) is available to provide regulatory compliance. A serial number dependent activation code has to be entered in the settings menu. After entering the activation code, a password to enter the administrator level can be defined.

With the user management a password identification is requested when switching on the instrument.

- If the password is successfully entered, the user gets access to the administrator level.
- Without password identification or the wrong password the user has limited access to the instrument functionalities.

Administrator level

1. Full access to the instrument functionalities
2. Access to the Service menu
3. Possibility to change the password
4. Connection to MeltingPoint Monitor Software possible

User level

1. Possibility to choose between melting point and boiling point
2. Access to the following parameters: start temperature, heating rate and end temperature
3. Selection of methods, but no editing and deleting
4. No access to: changing of date and time, calibration data and calibration menu.
5. No connection to: MeltingPoint Monitor Software

The user management setting for the password protection can be undone by deleting the password in the administrator mode and leaving the field blank. The user management setting can be reactivated with the activation key.

The activation key is only valid in the year of purchase.

For later activation please contact: registration@buchi.com

6.7 XML to PC data export

If no printer is connected to the MeltingPoint device, data can be sent to a PC by pushing the "XML2PC" button. The raw data is transmitted through the serial interface and can be received by the PC with the following settings:

Table 6-7: PC settings

Baud rate:	19200
Parity:	No
Data bit:	8
Stop bit:	1

No PC software is supplied to receive the XML data.

Picking up the data is the customers responsibility.

7 Maintenance

This section provides instructions on all maintenance work to be performed to keep the instrument in good working condition.



WARNING

All maintenance and repair work requiring the opening or removal of the instrument housing must be carried out by trained personnel and only with the tools provided for this purpose.



WARNING

Electrical hazard:

- Prior to any maintenance work on the instrument, switch off the power supply.



ATTENTION

Use only genuine BUCHI consumables and spare parts for any maintenance and repair work in order to assure continued system performance and reliability. Any modifications to the spare parts used should be carried out only with the prior written permission of the manufacturer.

7.1 Housing

Check the housing of your melting point instrument for defects (controls, plugs). The housing is coated with paint and should be cleaned only with a rag moistened in a soapy solution.

ATTENTION



Never use any halogenated solvents, acetone, or similar chemicals, because such cleaning agents may damage the instrument.

7.2 Glass window

Remove the glass window from the heating block periodically and wipe it clean with alcohol or acetone. Replace the window with a new one if it will not come clean completely.

7.3 Upkeep

The upkeep of the unit is mainly limited to:

- Periodic calibration of the temperature.

7.4 Cleaning the heating block

Remove broken capillaries from the heating block.

ATTENTION

- Wait for the heating block to cool down before touching it!



- Remove the cover.
- Follow the instructions mentioned below on the use of the cleaning tool 051978.



- If a melting point capillary is broken and is stuck in the heating block, use the cleaning tool (Order number: 051978).



- Remove the cover and glass holder with glass window.



- If glass parts of a melting point capillary are stuck in a hole of the metal heating block, use the cleaning tool as shown in the picture.

8 Troubleshooting

The following section describes how to resume operation of the instrument in the event of any minor problem. It lists some possible occurrences, their probable cause, and suggests how to remedy the problem. The troubleshooting table below lists possible instrument malfunctions and errors and describes courses of action that can be used by operators to correct some of those problems. The appropriate course of action is listed in the column "Remedy".

More complicated malfunctions or errors are usually handled by a BUCHI technical engineer who has access to the official service manuals. In this case, please contact your local BUCHI customer service agent.

8.1 Malfunctions and their remedy

Table 8-1: General malfunctions and their remedy

Malfunction	Possible cause	Remedy
Instrument does not work	Main switch off	Switch on mains switch
	Instrument is not connected to mains supply	Check mains connection
No or unreadable printout	Not activated in the settings	Activate automatic printout in the settings
	Bad cable connection	Check cable connection
	Printer switched OFF	Switch ON printer
	No paper	Replace paper roll
	Baud rate settings of printer faulty	See section 8.1.1
No or wrong result	Sample-specific preparations: Sample is not dry or is contaminated by another substance	Sample should be dried before use
	Sample decomposes during the melting process (formation of bubbles, sample turns brown, etc.)	
	Apparatus parameters: Apparatus is not or is poorly calibrated	Regular calibration of apparatus with BUCHI calibration standards or check with verification standards
	Setting point is too close to the melting point	Select setting point 5–10 °C below melting point
Instrument does not heat	Heating defective	Contact BUCHI customer service.

Table 8-2: Warning messages

Warning number	Possible cause	Remedy
Warning 01	Calibration outdated.	Calibrate or verify device.
Warning 02	Housing temperature too high.	Cool down device and check clearance of vent holes and fans. Check ambient temperature.
Warning 03	Device not calibrated.	Calibrate device.

Table 8-3: Error messages

Error number	Possible cause	Remedy
Error 01	Memory data loss, all data are reset.	Calibrate device. Incaseofrecurrencecontactcustomerservice.
Error 02	Automaticrestart,firmwareproblempossible.	Incaseofrecurrencecontactcustomerservice.
Error 03	Board temperature sensor defective.	Contact customer service.
Error 04	Temperature sensor defective.	Contact customer service.
Error 05	Heating defective.	Contact customer service.
Error 06	Cooling fan defective.	Contact customer service.
Error 07	Housing fan defective.	Contact customer service.
Error 08	Camera defective, communication loss.	Contact customer service.
Error 09	24 V fuse defective.	Contact customer service.
Error 10	24 V input voltage missing.	Contact customer service.
Error 11	Internal clock, power loss.	Contact customer service.
Error 13	5 V input voltage missing	Contact customer service.

NOTE

If several errors are pending, the one with the highest priority will be displayed.

8.1.1 Setting the printer baud rate

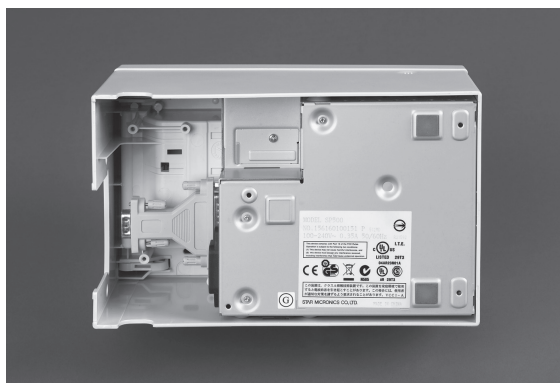

- Open compartment on the bottom of the printer.

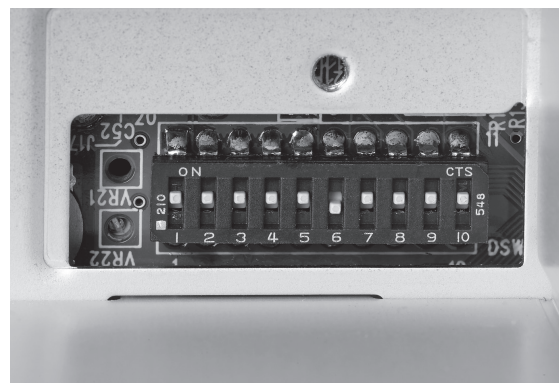

- The following setting should be selected.
1,2,3,4,5,7,8,9,10 = ON
6 = OFF

8.2 Customer service

Only authorized service personnel are allowed to perform repair work on the instrument. They have comprehensive technical training and knowledge of possible dangers that might arise from the instrument.

Contacts for official BUCHI customer service offices are available on the BUCHI website at: www.buchi.com. If malfunctions occur on your instrument or you have technical questions or application problems, please contact one of these offices.

Customer Service offers the following:

- Spare part delivery
- Repairs
- Technical advice

9 Shutdown, storage, transport, and disposal

This section provides instructions on how to shut down the instrument, how to pack it for storage or transport, and specifies the storage and shipping conditions.

9.1 Storage and transport



WARNING
Biohazard:

- Remove all dangerous substances from the instrument, and clean it thoroughly.
- Store and transport the instrument in its original packaging.



WARNING
Electrical hazard:

- Always remove the power cord from the socket first to avoid having live cables in the laboratory.

9.2 Disposal

To dispose of the instrument in an environmentally friendly manner, a list of materials is given in section 3.3, please ensure that the components are separated and recycled correctly. Please follow current regional and local laws concerning disposal.

10 Spare parts

This section lists spare parts, accessories and optional extras, including all of the relevant order information for ordering from BUCHI. Always state the product designation and part number when ordering any spare parts.

To ensure optimum system performance and reliability, use only genuine BUCHI consumables and spare parts for maintenance and repair. Prior written permission of the manufacturer should be obtained before any modifications are made to the spare parts used.

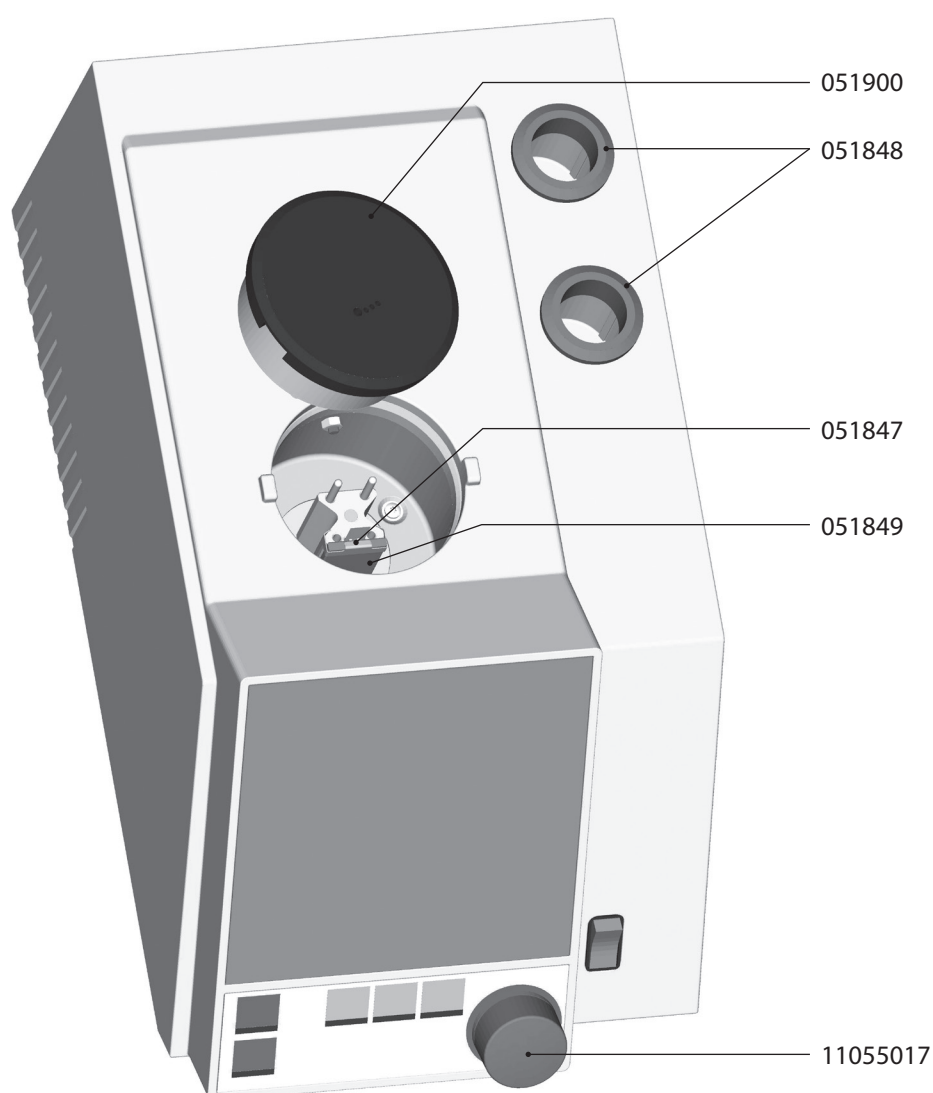

Fig. 10.1: Spare parts

Table 10-1: Spare parts

Product	Order number	Product	Order number
Cover	051900	Ring	051848
Glass holder	051847	Rotary knob	11055017
Glass window	051849		

11 Declarations and requirements

11.1 FCC requirements (for USA and Canada)

English:

This equipment has been tested and found to comply with the limits for a Class A digital device, pursuant to both Part 15 of the FCC Rules and the radio interference regulations of the Canadian Department of Communications. These limits are designed to provide reasonable protection against harmful interference when the equipment is operated in a commercial environment.

This equipment generates, uses, and can radiate radio frequency energy and, if not installed and used in accordance with the instruction manual, may cause harmful interference to radio communications. Operation of this equipment in a residential area is likely to cause harmful interference, in which case users will be required to correct the interference at their own expense.

Français:

Cet appareil a été testé et s'est avéré conforme aux limites prévues pour les appareils numériques de classe A et à la partie 15 des réglementations FCC ainsi qu'à la réglementation des interférences radio du Canadian Department of Communications. Ces limites sont destinées à fournir une protection adéquate contre les interférences néfastes lorsque l'appareil est utilisé dans un environnement commercial.

Cet appareil génère, utilise et peut irradier une énergie à fréquence radioélectrique, il est en outre susceptible d'engendrer des interférences avec les communications radio, s'il n'est pas installé et utilisé conformément aux instructions du mode d'emploi. L'utilisation de cet appareil dans les zones résidentielles peut causer des interférences néfastes, auquel cas l'exploitant sera amené à prendre les dispositions utiles pour palier aux interférences à ses propres frais.

BUCHI Affiliates:

Europe

Switzerland/Austria

BÜCHI Labortechnik AG
CH – 9230 Flawil
T +41 71 394 63 63
F +41 71 394 64 64
buchi@buchi.com
www.buchi.com

Italy

BUCHI Italia s.r.l.
IT – 20010 Cornaredo (MI)
T +39 02 824 50 11
F +39 02 575 12 855
italia@buchi.com
www.buchi.com/it-it

Benelux

BÜCHI Labortechnik GmbH
Branch Office Benelux
NL – 3342 GT Hendrik-Ido-Ambacht
T +31 78 684 94 29
F +31 78 684 94 30
benelux@buchi.com
www.buchi.com/bx-en

Russia

BUCHI Russia/CIS
Russia 127287 Moscow
T +7 495 36 36 495
russia@buchi.com
www.buchi.com/ru-ru

France

BUCHI Sarl
FR – 94656 Rungis Cedex
T +33 1 56 70 62 50
F +33 1 46 86 00 31
france@buchi.com
www.buchi.com/fr-fr

United Kingdom

BUCHI UK Ltd.
GB – Oldham OL9 9QL
T +44 161 633 1000
F +44 161 633 1007
uk@buchi.com
www.buchi.com/gb-en

Germany

BÜCHI Labortechnik GmbH
DE – 45127 Essen
T +800 414 0 414 0 (Toll Free)
T +49 201 747 49 0
F +49 201 747 49 20
deutschland@buchi.com
www.buchi.com/de-de

Germany

BÜCHI NIR-Online
DE – 69190 Walldorf
T +49 6227 73 26 60
F +49 6227 73 26 70
nir-online@buchi.com
www.nir-online.de

America

Brazil

BUCHI Brasil Ltda.
BR – Valinhos SP 13271-200
T +55 19 3849 1201
F +55 19 3849 2907
brasil@buchi.com
www.buchi.com/br-pt

USA/Canada

BUCHI Corporation
US – New Castle, DE 19720
T +1 877 692 8244 (Toll Free)
T +1 302 652 3000
F +1 302 652 8777
us-sales@buchi.com
www.buchi.com/us-en

Asia

China

BUCHI China
CN – 200233 Shanghai
T +86 21 6280 3366
F +86 21 5230 8821
china@buchi.com
www.buchi.com/cn-zh

India

BUCHI India Private Ltd.
IN – Mumbai 400 055
T +91 22 667 75400
F +91 22 667 18986
india@buchi.com
www.buchi.com/in-en

Indonesia

PT. BUCHI Indonesia
ID – Tangerang 15321
T +62 21 537 62 16
F +62 21 537 62 17
indonesia@buchi.com
www.buchi.com/id-in

Japan

Nihon BUCHI K.K.
JP – Tokyo 110-0008
T +81 3 3821 4777
F +81 3 3821 4555
nihon@buchi.com
www.buchi.com/jp-ja

Korea

BUCHI Korea Inc.
KR – Seoul 153-782
T +82 2 6718 7500
F +82 2 6718 7599
korea@buchi.com
www.buchi.com/kr-ko

Malaysia

BUCHI Malaysia Sdn. Bhd.
MY – 47301 Petaling Jaya,
Selangor
T +60 3 7832 0310
F +60 3 7832 0309
malaysia@buchi.com
www.buchi.com/my-en

Singapore

BUCHI Singapore Pte. Ltd.
SG – Singapore 609919
T +65 6565 1175
F +65 6566 7047
singapore@buchi.com
www.buchi.com/sg-en

Thailand

BUCHI (Thailand) Ltd.
TH – Bangkok 10600
T +66 2 862 08 51
F +66 2 862 08 54
thailand@buchi.com
www.buchi.com/th-th

BUCHI Support Centers:

South East Asia

BUCHI (Thailand) Ltd.
TH-Bangkok 10600
T +66 2 862 08 51
F +66 2 862 08 54
bacc@buchi.com
www.buchi.com/th-th

Middle East

BÜCHI Labortechnik AG
UAE – Dubai
T +971 4 313 2860
F +971 4 313 2861
middleeast@buchi.com
www.buchi.com

Latin America

BUCHI Latinoamérica S. de R.L. de C.V.
MX – Mexico City
T +52 55 9001 5386
latinoamerica@buchi.com
www.buchi.com/es-es

We are represented by more than 100 distribution partners worldwide.
Find your local representative at: www.buchi.com